

Labette Community College
Board of Trustees Special Meeting Agenda
Wednesday, April 7, 2021
4:00 p.m.
Cardinal Event Center

- I. Adoption of Agenda (Exhibit 1)
- II. Reports and/or Board Discussion
 - A. Faculty Senate Report
- III. Old Business (Action, Report, or Discussion)
- IV. New Business (Action, Report, or Discussion)
 - A. Setting the GMP (Guaranteed Maximum Price).....(Agenda Item IV. A)
 - B. Financing Bid Specs(Agenda Item IV.B)
 - C. Purchase of Bleachers.....(Agenda Item IV.C)
(Exhibit 2)
- V. Public Comment

The Board of Trustees agenda shall contain one opportunity for public comment. This structure has been designed to provide the public with an opportunity to comment on any topic. The Chair of the Board explains the Board’s approach to the public comment with the following statement: **“At this time we invite anyone in the audience to speak to the Board about any item or concern that pertains to the college. By policy, at this time the Board will not take any action on any item or concern, but we will be happy to take it under advisement for possible future action.”** The Board also retains the right to set time limits on public comment.

In the event that a large number of citizens are present and wish to speak in favor or in opposition to an issue before the Board, the Board reserves the right to poll the number of citizens in favor of and in opposition to the issue at hand as well as to limit the number of spokespersons representing opposing viewpoints. The Board also retains the right to set time limits as deemed appropriate.

- VI. Next Regular Board Meeting: Thursday, April 8, 2021 at 5:30 p.m., Tentative Agenda Items.
- VII. Adjournment

**MID-STATES SCHOOL
EQUIPMENT CO. INC.**

810C NW MAIN ST.
LEE'S SUMMIT, MO. 64086
816-282-7838-816-282-7837 fax

QUOTATION

3/2/21

Labette County CC Bleacher Replacement

National IPA Cooperative Pricing

- 1 group wall attached 43', 6 rows
- 1 group wall attached 32'6", 6 rows
- 1 group wall attached 93', 9 rows

All groups will have the following specifications:

- 12" rise
- 24" spacing
- Panelam decking 5/8"
- 11 1/2" deck filler
- 208/230 VAC, Three phase IDS power system
- Self storing end rails starting at row 3
- End curtain
- 36" x 24" permanent wheel chair spaces
- Galvanized nose and rear beam
- 48" aisles w/smart rails
- Material Price \$71,465.00
- Freight \$ 3,432.00
- Installation \$17,197.00
- Total National IPA \$92,094.00

Bid pricing for the exact above specifications, buying from Mid States School Equipment delivered and installed. \$83,406.00

Bid pricing for the exact above specifications except group 3 Has 8 rows mounted in front of the columns with a 37 1/2" Back deck. \$86,460.00

If you have any questions please feel free to give us a call.

**Respectively Submitted;
Charlie Burt
President**

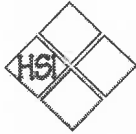

Heartland Seating Inc
spectator seating specialists



Interkal
Spectator Seating World Wide
www.interkal.com



Greenbush
Southeast Kansas Education Service Center
RFP 20.2 ESC-BLEACHERS2020

EXHIBIT 2

Contracts made out to:	
Heartland Seating, Inc.	Phone: 913-268-0069
c/o Monty Kinman	Fax: 913-962-0803
11222 Johnson Drive	
Shawnee, KS 66203	

PROJECT NAME: LABETTE COUNTY COMMUNITY COLLEGE
SCOPE OF WORK: TELESCOPING BLEACHERS

DATE: MARCH 11, 2021

<p>Option 1 per attached drawing:</p> <ul style="list-style-type: none"> ◆ One bank (North) of wall-attached, electrically powered, telescopic bleachers 6 rows x 35'; 10 1/4" rise per row, 24" row spacing and 10" Interkal Excel seat modules available in 15 standard colors. <ul style="list-style-type: none"> • Self-storing end rails - (2) Two Vinyl End Curtains • Two (2) Permanent notchouts with rails ◆ One bank (North) of wall-attached, electrically powered, telescopic bleachers 6 rows x 45'1"; 10 1/4" rise per row, 24" row spacing and 10" Interkal Excel seat modules available in 15 standard colors. <ul style="list-style-type: none"> • Self-storing end rails - (2) Two Vinyl End Curtains • Two (2) Permanent notchouts with rails ◆ South bank - free-standing floor attached telescopic bleachers 8 rows x 93'8 1/2"; 11 1/2" rise per row, 24" row spacing and 10" Interkal Excel seat modules available in 15 standard colors. <ul style="list-style-type: none"> • Three (3) Foot level aisle with rails • One (1) Vinyl End Curtain • Two (2) Permanent notchouts with rails - Two (2) Recoverable notchouts without rails • Extended Closure around Columns with seat level filler <p style="text-align: right;">TOTAL DELIVERED AND INSTALLED PRICE</p>	\$108,640
<p>Option 2 per attached drawing:</p> <ul style="list-style-type: none"> ◆ One bank (North side) of wall-attached, electrically powered, telescopic bleachers 6 rows x 35'; 10 1/4" rise per row, 24" row spacing and 10" Interkal Excel seat modules available in 15 standard colors. <ul style="list-style-type: none"> • Self-storing end rails - (2) Two Vinyl End Curtains • Two (2) Permanent notchouts with rails ◆ One bank (North side) of wall-attached, electrically powered, telescopic bleachers 6 rows x 45'1"; 10 1/4" rise per row, 24" row spacing and 10" Interkal Excel seat modules available in 15 standard colors. <ul style="list-style-type: none"> • Self-storing end rails - (2) Two Vinyl End Curtains • Two (2) Permanent notchouts with rails ◆ South bank - free-standing floor attached telescopic bleachers 7 rows x 93'8 1/2"; 11 1/2" rise per row, 24" row spacing and 10" Interkal Excel seat modules available in 15 standard colors. <ul style="list-style-type: none"> • Three (3) Column cutouts – with extended bleacher closure around and seat level filler • 3 foot level aisle with rails • Self-storing end rails -One (1) Vinyl End Curtain • Two (2) Permanent notchouts with rails -Two (2) Recoverable notchouts without rails • Last 3 rows @ 32" span with automatic backrests <p style="text-align: right;">TOTAL DELIVERED AND INSTALLED PRICE</p>	\$135,667
Removal and disposal of existing bleachers is included in each option pricing.	

11222 Johnson Drive, Shawnee, KS 66203
www.heartlandseating.com

Phone: (913) 268-0069 Fax: (913) 962-0803
sales@heartlandseating.com



Heartland Seating Inc
spectator seating specialists



Interkal
Spectator Seating World Wide
www.interkal.com



IMPORTANT – TERMS AND CONDITIONS:

This quotation shall be included by attachment with contract and is based on delivery third quarter (3rd) 2021 (quarterly adjustments may apply). Quotation is subject to acceptance within 60 days of issuance. Allow 4 to 5 weeks for approval drawings upon receipt of contract, project manual and plans. Allow for field check and approval time, then 90 to 120 days lead time to delivery (or call to discuss fast track options, if needed). For installations onto wood floors with finish coat, allow minimum 10 days cure for water base finished and 21 days for oil base finished before receipt of bleachers for installation. Site and gym are to be accessible for unload, staging materials in gym and beginning installation upon receipt of materials to avoid delays and added handling storage charges. **Multiple moves, extra handling and or storage are not included.** Up to 45 days prior to delivery, orders may be pulled from production and rescheduled to Interkal's next available production date. Unless listed in the above scope "description" pricing does not include any miscellaneous licensing, permits, or fees. Mandatory progress meetings shall be attended only when materials are on site as our installations generally occur at the end of the project. No Bonds have been included in pricing.

Terms (unless specified otherwise): Materials, Net 30 days. Labor, 90% monthly estimate, balance upon completion. 1.5% per month to be charged on past due amounts. Applicable taxes must be added.

Should you wish to have any of the above conditions and terms altered or included with our bid, please call for revised quote.

Thank you for the opportunity to be of service. Good luck with your project.

Sincerely,

Monty Kinman

Monty Kinman
Heartland Seating, Inc.
Sales Representative

11222 Johnson Drive, Shawnee, KS 66203
www.heartlandseating.com

Phone: (913) 268-0069 Fax: (913) 962-0803
sales@heartlandseating.com

Labette CC North

QTY	DESCRIPTION	SEATS	RISE	SPAN
Bank #1	6 Row Friction Power Wall Attached 45'-1" W/ 10" Excel Seat Module -00 TBE	142	10.25	24
2	6 Row Foot Level Aisles W/ Self-Storing F-Rail			
2	6 Row Intermediate Steps			
2	1 Row 3'-0 1/4" Notchout W/ Front Rail			
1	6 Row Self-Storing End Rails			
1	Vinyl End Curtains RH			
1	Last Row Seat Level Filler Board			
Bank #2	6 Row Friction Power Wall Attached 35'-0 1/2" W/ 10" Excel Seat Module -00 TBE	115	10.25	24
1	6 Row Foot Level Aisles W/ Self-Storing F-Rail			
1	6 Row Intermediate Steps			
2	1 Row 3'-0 1/4" Notchout W/ Front Rail			
1	6 Row Self-Storing End Rails			
1	Operation Controller (pendant switch)			
1	Vinyl End Curtains LH			
1	Last Row Seat Level Filler Board			

NOTES:

TOTAL SEATS

257



5981 East Cork Street, PO Box 2107, Kalamazoo, MI 49003-2107
 telephone (269) 349-1521 fax (269) 349-6530

Labette CC North
 Bank 2 - 35'-0 1/2" Friction Power
 Building Code: IBC 2018
 36'-6" Clear Dimension
 6 Row - 24 Span - 10.25 Rise
 115 seats (EM10)
 NOT TO CODE

- POWER REQUIREMENTS:**
1. Wiring and non-fusible safety switch(es) suitable for the line voltage to be provided by electrical contractor or others with branch circuit protection to each not exceeding 15 amps.
 2. Branch circuit protection devices by others to be accessible when platforms are closed.
 3. Verify electrical information:
 Circuit 3 Phase, 208-230 Volts, 60 Hertz.
 Each 1/2 Horse Power Motor Draws 2.0-2.2 amps. Full Load.
 Motors run simultaneously.
 4. Junction box(es) by electrical contractor to be mounted at locations TBD, 5' AFF.
 Typical location shall be at section joints.

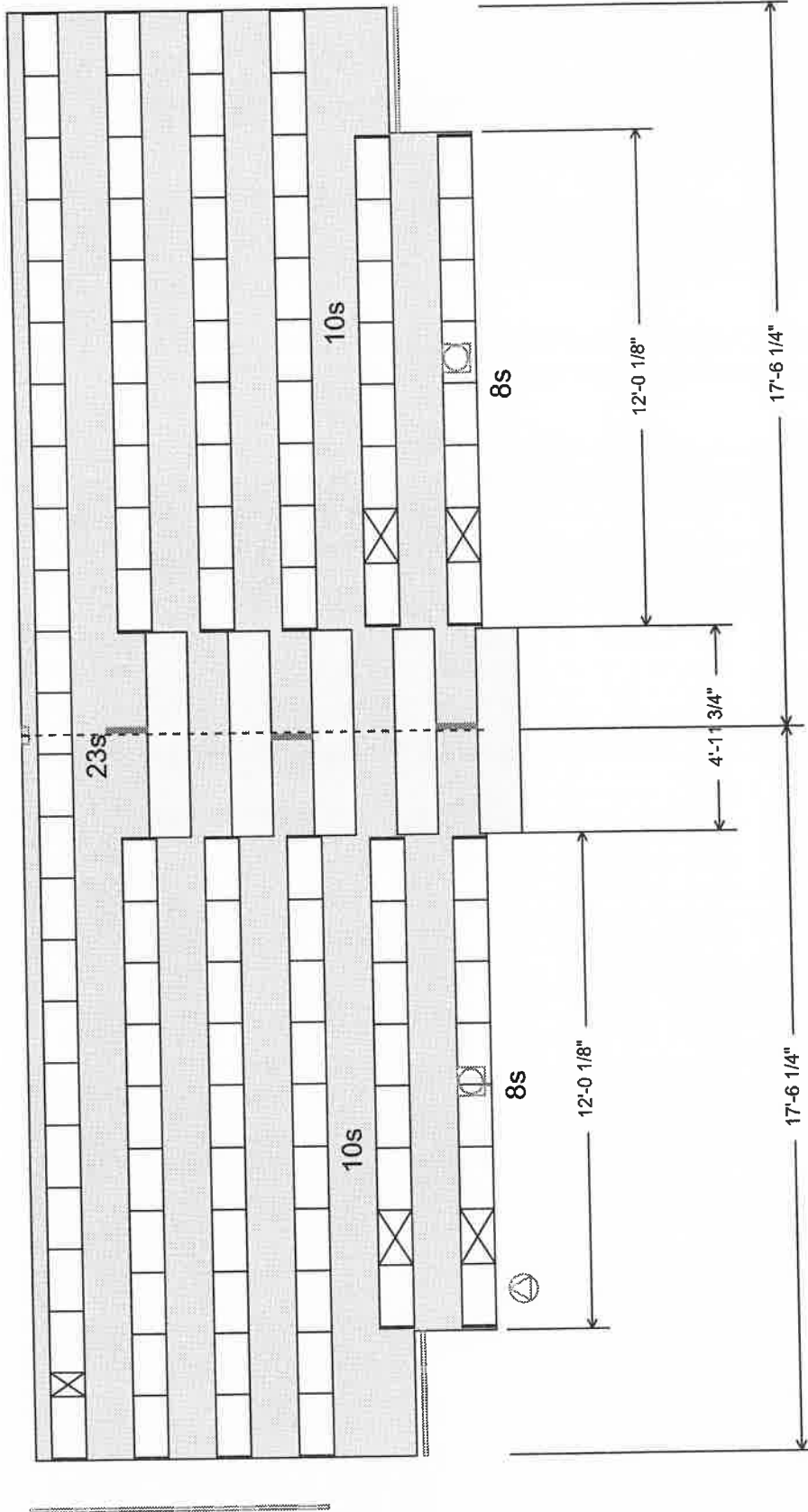

5981 East Cork Street, PO Box 2107, Kalamazoo, MI 49003-2107
 telephone (269) 349-1521 fax (269) 349-6530



Drawings produced by this program are only as good as the information provided. These drawings are PRELIMINARY only.
 All drawings created are subject to Interkal approval for design and construction capability.
 Printed: March 8, 2021 v2.7.5

Labette CC North
 Bank 1 - 45'-1" Friction Power
 Building Code: IBC 2018
 46'-6 1/2" Clear Dimension
 6 Row - 24 Span - 10.25 Rise
 142 seats (EM10)
 NOT TO CODE

- POWER REQUIREMENTS:**
1. Wiring and non-fusible safety switch(es) suitable for the line voltage to be provided by electrical contractor or others with branch circuit protection to each not exceeding 15 amps.
 2. Branch circuit protection devices by others to be accessible when platforms are closed.
 3. Verify electrical information:
 Circuit 3 Phase, 208-230 Volts, 60 Hertz.
 Each 1/2 Horse Power Motor Draws 2.0-2.2 amps. Full Load.
 Motors run simultaneously.
 4. Junction box(es) by electrical contractor to be mounted at locations TBD, 5' AFF.
 Typical location shall be at section joints.

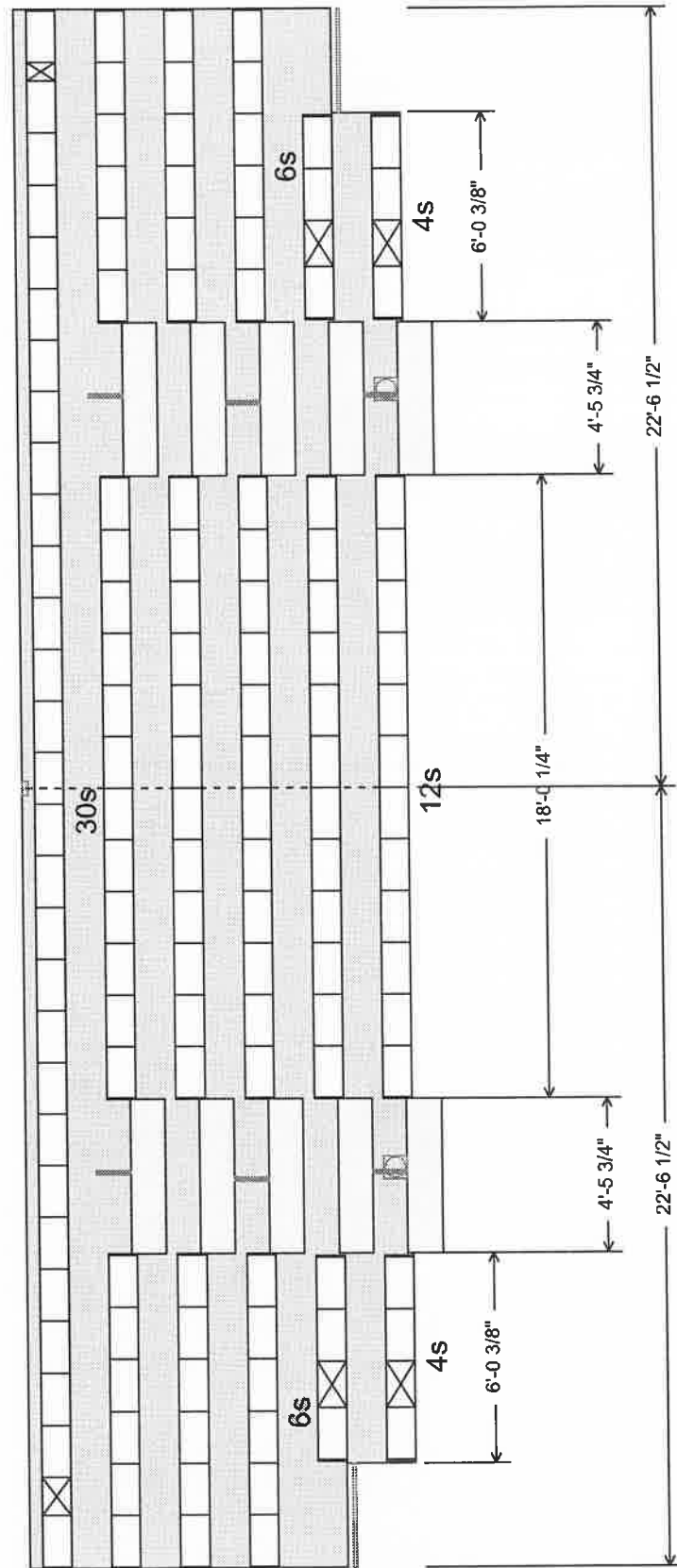

Labette CC North

Bank 1 - 45'-1" Friction Power

Building Code: IBC 2018

6 Row - 24 Span - 10.25 Rise - Wall Attached

142 seats (EM10)

NOT TO CODE

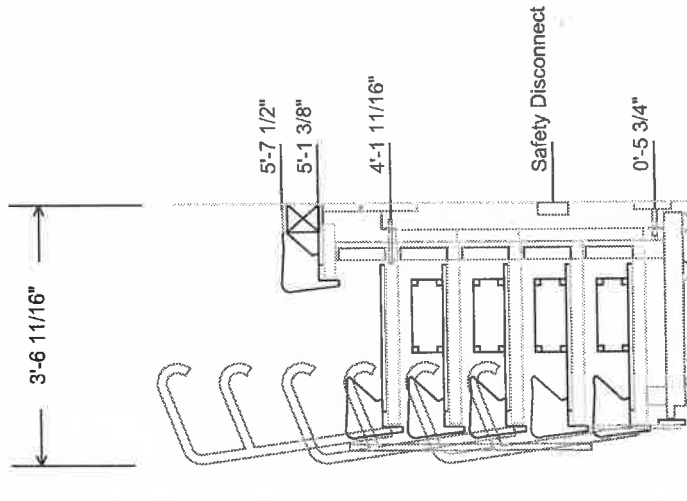
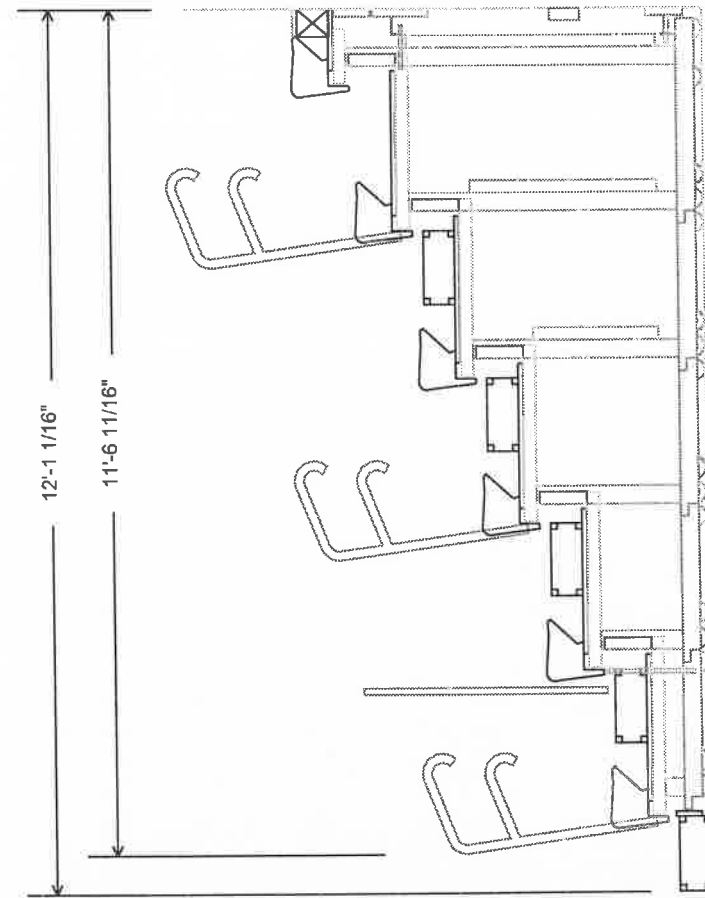

FLOOR IS CONCRETE

WALL IS BLOCK

Safety Disconnect

EXHIBIT 2



5981 East Cork Street, PO Box 2107, Kalamazoo, MI 49003-2107
 telephone (269) 349-1521 fax (269) 349-6530

Drawings produced by this program are only as good as the information provided. These drawings are PRELIMINARY only.
 All drawings created are subject to Interkal approval for design and construction capability.
 Printed: March 8, 2021 VZ7.5

Side Elevation View A1

Labette CC South 8row.24in

QTY	DESCRIPTION	SEATS	RISE	SPAN	
Bank #1	8 Row Friction Power Free Standing/Floor Attached W/ 10" Excel Seat Module -00 TBE	93'-8 1/2"	423	11.5	24
3	8 Row Foot Level Aisles W/ Self-Storing F-Rail				
3	8 Row Intermediate Steps				
3	1'-3" x 2'-6" Column Cut Out				
2	1 Row 3'-0 1/4" Notchout W/ Front Rail				
2	1 Row Recoverable 3'-0 1/4" Notchout				
1	8 Row Self-Storing End Rails				
1	Vinyl End Curtains LH				
1	Last Row Seat Level Filler Board				

NOTES:

TOTAL SEATS

423



5981 East Cork Street, PO Box 2107, Kalamazoo, MI 49003-2107
 telephone (269) 349-1521 fax (269) 349-6530

Labette CC South 8row.24in

Bank 1 - 93'-8 1/2" Friction Power
 Building Code: IBC 2018
 95'-2" Clear Dimension
 8 Row - 24 Span - 11.5 Rise
 423 seats (EM10)

POWER REQUIREMENTS:

1. Wiring and non-fusible safety switch(es) suitable for the line voltage to be provided by electrical contractor or others with branch circuit protection to each not exceeding 15 amps.
2. Branch circuit protection devices by others to be accessible when platforms are closed.
3. Verify electrical information:
 Circuit: 3 Phase, 208-230 Volts, 60 Hertz.
 Each 1/2 Horse Power Motor Draws 2.0-2.2 amps. Full Load.
 Motors run simultaneously.
4. Junction box(es) by electrical contractor to be mounted at locations TBD, 5' AFF.
 Typical location shall be at section joints.

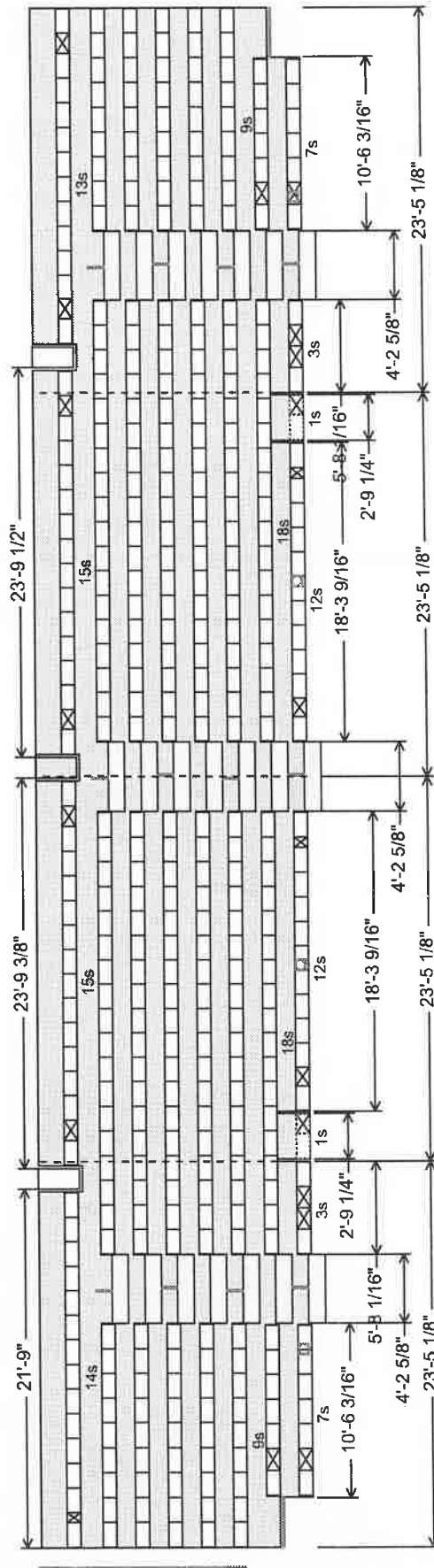

5981 East Cork Street, PO Box 2107, Kalamazoo, MI 49003-2107
 telephone (269) 349-1521 fax (269) 349-6530

Drawings produced by this program are only as good as the information provided. These drawings are PRELIMINARY only.
 All drawings must be subject to Interkal approval for design and construction capability.
 Printed: March 8, 2021 V2.7.5

Labette CC South 8row.24in

Bank 1 - 93-8 1/2" Friction Power
 Building Code: IBC 2018
 8 Row - 24 Span - 11.5 Rise - Free Standing/Floor Attached
 423 seats (EM10)
 5'-6 1/2" Court To Step Dimension
 6'-0 7/8" Court To First Row Dimension

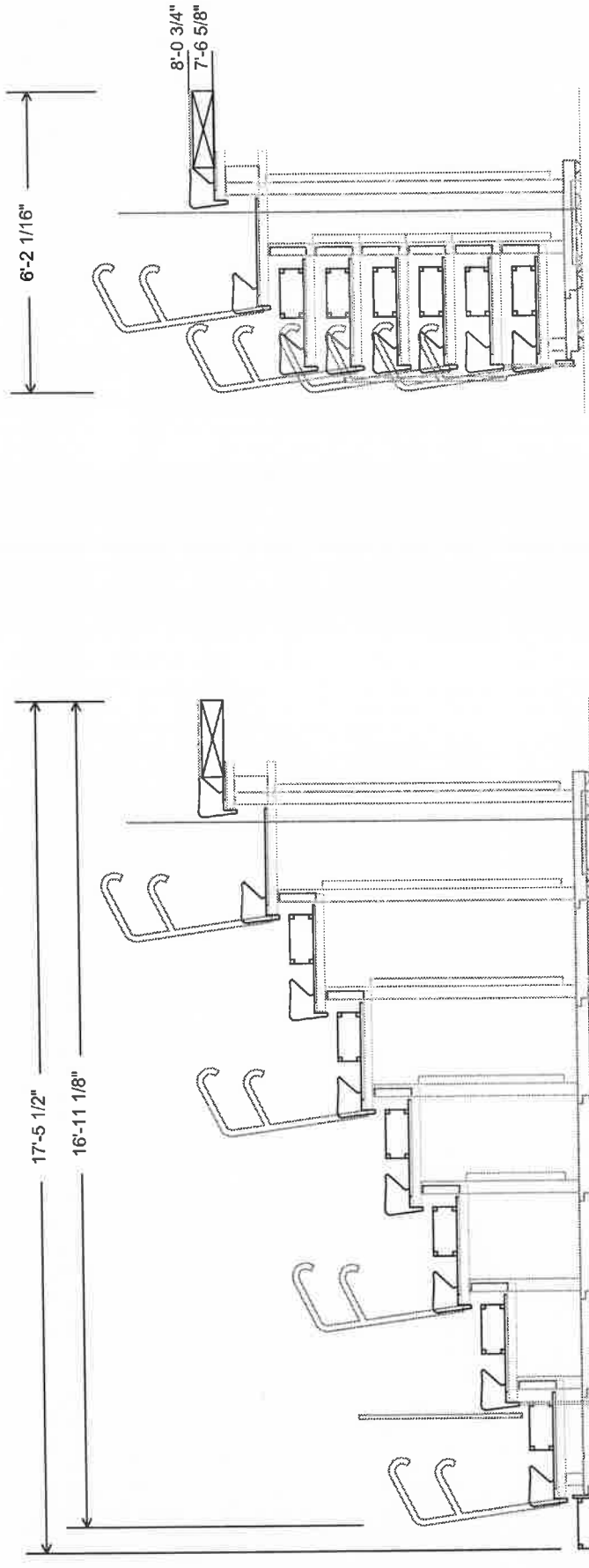

FLOOR IS CONCRETE

EXHIBIT 2

Side Elevation View A1

5981 East Cork Street, PO Box 2107, Kalamazoo, MI 49003-2107
 telephone (269) 349-1521 fax (269) 349-6530



Drawings produced by this program are only as good as the information provided. These drawings are PRELIMINARY only.
 All drawings created are subject to Interkal approval for design and construction capability.
 Printed: March 8, 2021 v2.7.5

Labette CC North

QTY	DESCRIPTION	SEATS	RISE	SPAN
Bank #1	6 Row Friction Power Wall Attached 45'-1" W/ 10" Excel Seat Module -00 TBE	142	10.25	24
2	6 Row Foot Level Aisles W/ Self-Storing F-Rail			
2	6 Row Intermediate Steps			
2	1 Row 3'-0 1/4" Notchout W/ Front Rail			
1	6 Row Self-Storing End Rails			
1	Vinyl End Curtains RH			
1	Last Row Seat Level Filler Board			
Bank #2	6 Row Friction Power Wall Attached 35'-0 1/2" W/ 10" Excel Seat Module -00 TBE	115	10.25	24
1	6 Row Foot Level Aisles W/ Self-Storing F-Rail			
1	6 Row Intermediate Steps			
2	1 Row 3'-0 1/4" Notchout W/ Front Rail			
1	6 Row Self-Storing End Rails			
1	Operation Controller (pendant switch)			
1	Vinyl End Curtains LH			
1	Last Row Seat Level Filler Board			

NOTES:

TOTAL SEATS

257



5981 East Cork Street, PO Box 2107, Kalamazoo, MI 49003-2107
 telephone (269) 349-1521 fax (269) 349-6530

Labette CC North

Bank 2 - 35'-0" 1/2" Friction Power
 Building Code: IBC 2018
 36'-6" Clear Dimension
 6 Row - 24 Span - 10.25 Rise
 115 seats (EM10)
 NOT TO CODE

POWER REQUIREMENTS:

1. Wiring and non-fusible safety switch(es) suitable for the line voltage to be provided by electrical contractor or others with branch circuit protection to each not exceeding 15 amps.
2. Branch circuit protection devices by others to be accessible when platforms are closed.
3. Verify electrical information:
 Each 3 Phase, 208-230 Volts, 60 Hertz.
 Each 1/2 Horse Power Motor Draws 2.0-2.2 amps. Full Load.
 Motors run simultaneously.
4. Junction box(es) by electrical contractor to be mounted at locations TBD, 5' AFF.
 Typical location shall be at section joints.

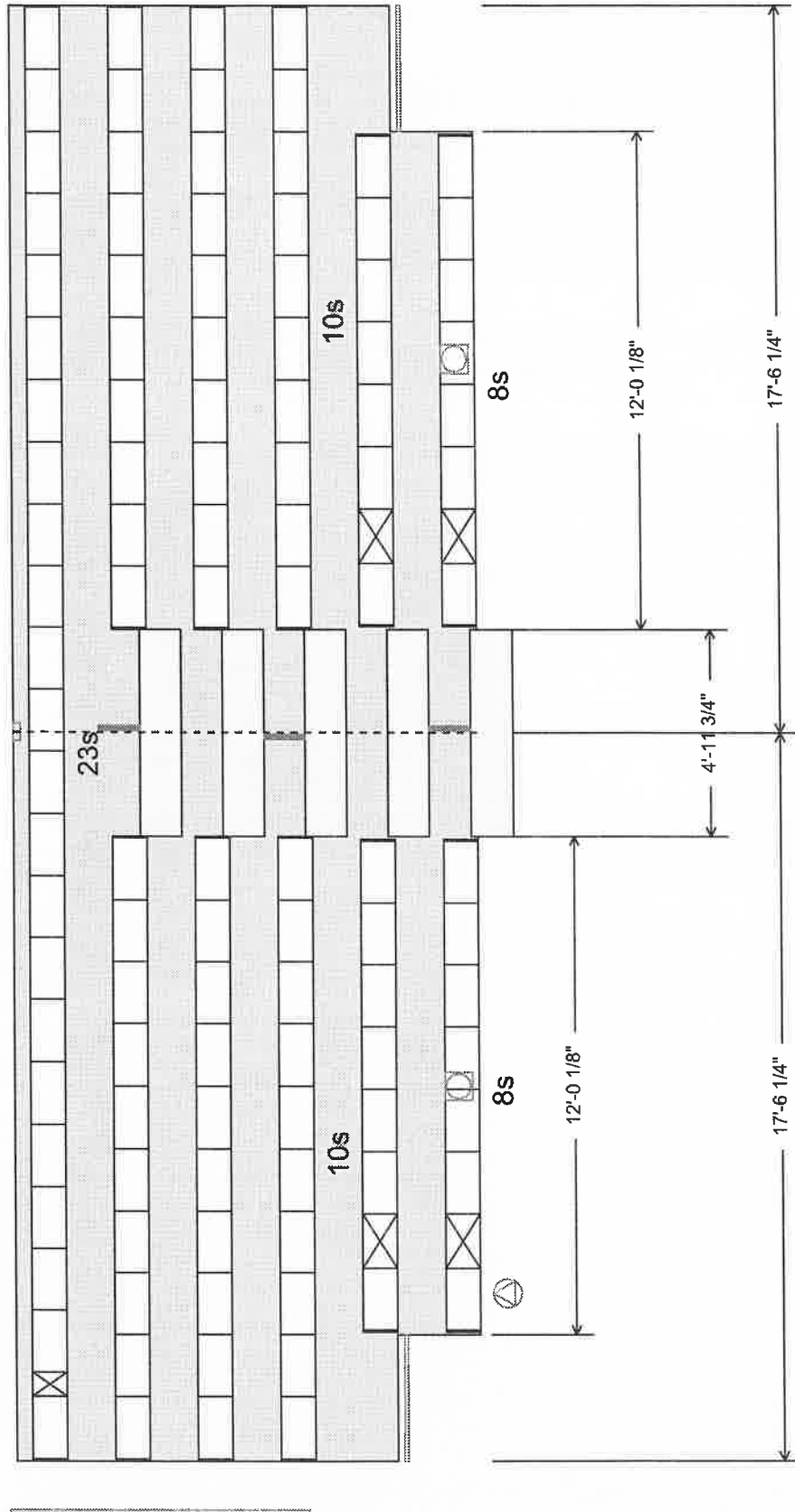

5981 East Cork Street, PO Box 2107, Kalamazoo, MI 49003-2107
 telephone (269) 349-1521 fax (269) 349-6530

Drawings produced by this program are only as good as the information provided. These drawings are PRELIMINARY only.
 All drawings created are subject to Interkal approval for design and construction capability.
 Printed: March 8, 2021 v2.7.5

Labette CC North
 Bank 1 - 45'-1" Friction Power
 Building Code: IBC 2018
 46'-6 1/2" Clear Dimension
 6 Row - 24 Span - 10.25 Rise
 142 seats (EM10)
 NOT TO CODE

- POWER REQUIREMENTS:**
1. Wiring and non-fusible safety switch(es) suitable for the line voltage to be provided by electrical contractor or others with branch circuit protection to each not exceeding 15 amps.
 2. Branch circuit protection devices by others to be accessible when platforms are closed.
 3. Verify electrical information:
 Circuit 3 Phase, 208-230 Volts, 60 Hertz.
 Each 1/2 Horse Power Motor Draws 2.0-2.2 amps. Full Load.
 Motors run simultaneously.
 4. Junction box(es) by electrical contractor to be mounted at locations TBD, 5' AFF.
 Typical location shall be at section joints.

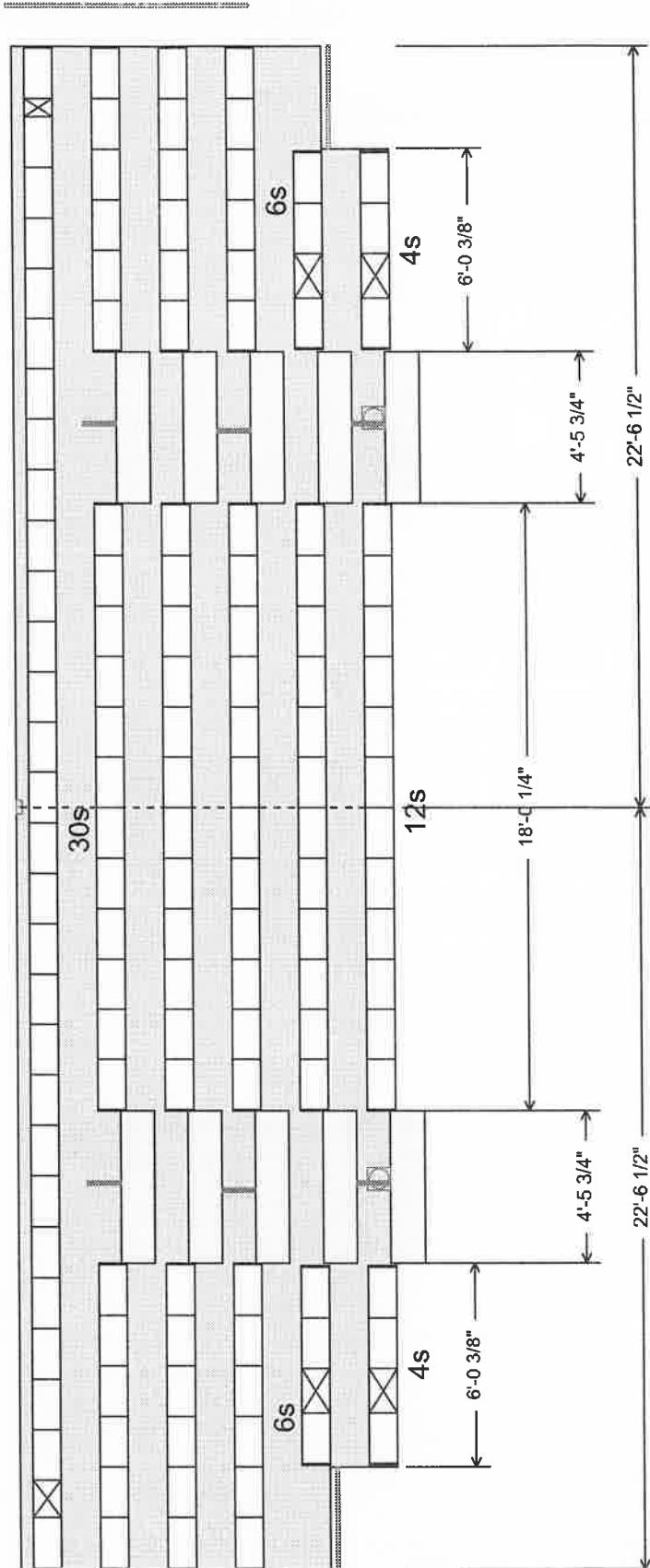

Labette CC North

Bank 1 - 45'-1" Friction Power

Building Code: IBC 2018

6 Row - 24 Span - 10.25 Rise - Wall Attached

142 seats (EM10)

NOT TO CODE

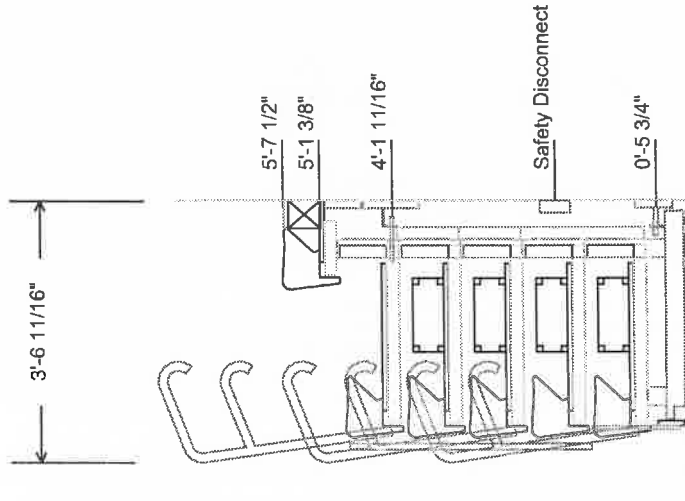
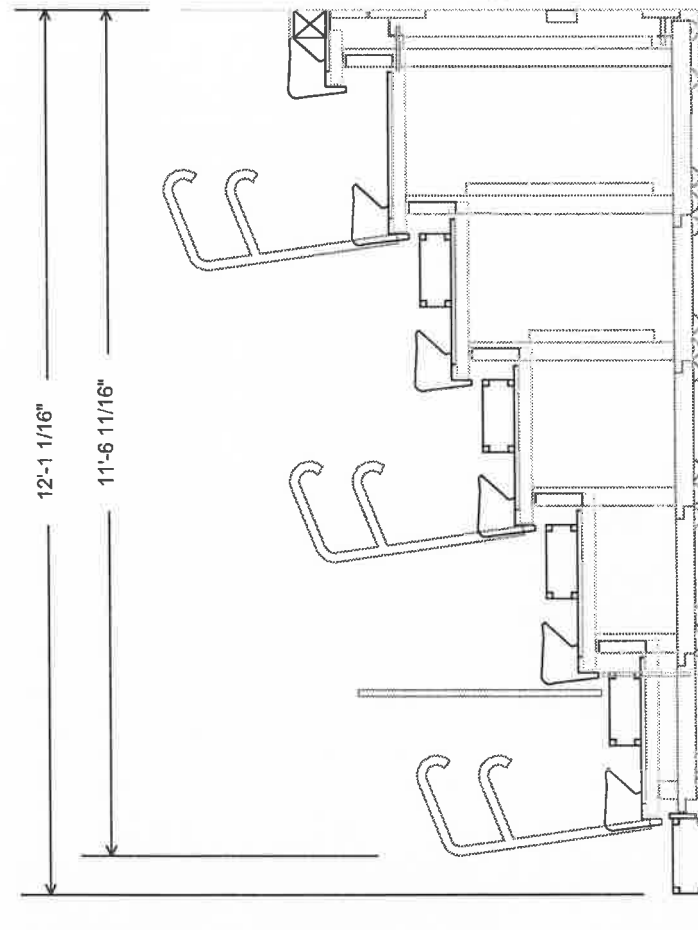

FLOOR IS CONCRETE

WALL IS BLOCK

EXHIBIT 2

Side Elevation View A1



5981 East Cork Street, PO Box 2107, Kalamazoo, MI 49003-2107
 telephone (269) 349-1521 fax (269) 349-6530

Drawings produced by this program are only as good as the information provided. These drawings are PRELIMINARY only.
 All drawings created are subject to Interkal approval for design and construction capability.
 Printed: March 8, 2021 v2.7.5

Labette CC South backs

QTY	DESCRIPTION	SEATS	RISE	SPAN
Bank #1	7 Row Friction Power Free Standing/Floor Attached 93'-8 1/2" W/ 10" Excel Seat Module -00 TBE	363	11.5	24 32
3	7 Row Foot Level Aisles W/ Quarter Turn Rail			
3	7 Row Intermediate Steps			
3	1'-3" x 2'-6" Column Cut Out			
2	1 Row 3'-0 1/4" Notchout W/ Front Rail			
2	1 Row Recoverable 3'-0 1/4" Notchout			
1	7 Row Self-Storing End Rails			
1	ComfoBack® Back Rest (auto plastic)			
1	Vinyl End Curtains LH			
1	Last Row Seat Level Filler Board			

NOTES:

TOTAL SEATS



5981 East Cork Street, PO Box 2107, Kalamazoo, MI 49003-2107
 telephone (269) 349-1521 fax (269) 349-6530

Labette CC South backs

Bank 1 - 93'-8 1/2" Friction Power
 Building Code: IBC 2018
 95'-2" Clear Dimension
 7 Row - 24/32 Span - 11.5 Rise
 363 seats (EM10)

- POWER REQUIREMENTS:**
1. Wiring and non-fusible safety switch(es) suitable for the line voltage to be provided by electrical contractor or others with branch circuit protection to each not exceeding 15 amps.
 2. Branch circuit protection devices by others to be accessible when platforms are closed.
 3. Verify electrical information:
 Each 3 Phase, 208-230 Volts, 60 Hertz.
 Each 1/2 Horse Power Motor Draws 2.0-2.2 amps. Full Load.
 Motors run simultaneously.
 4. Junction box(es) by electrical contractor to be mounted at locations TBD, 5' AFF.
 Typical location shall be at section joints.

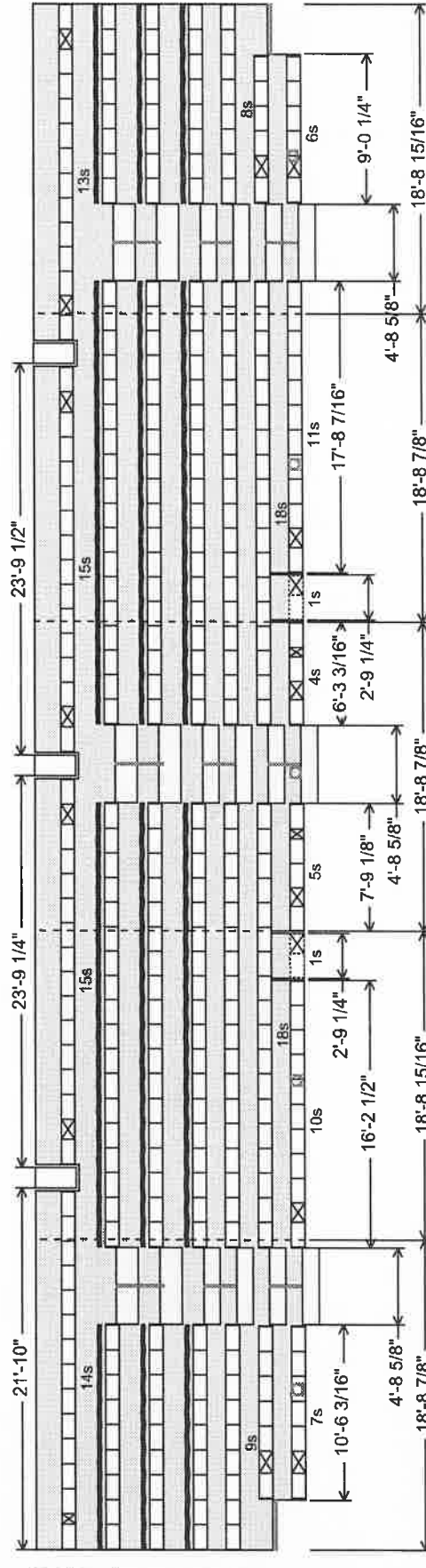

5981 East Cork Street, PO Box 2107, Kalamazoo, MI 49003-2107
 telephone (269) 349-1521 fax (269) 349-6530



Drawings produced by this program are only as good as the information provided. These drawings are PRELIMINARY only.
 All drawings created are subject to internal approval for design and construction capability.
 Printed: March 8, 2021 v2.7.5

Labette CC South backs

Bank 1 - 93'-8 1/2" Friction Power
 Building Code: IBC 2018
 7 Row - 24/32 Span - 11.5 Rise - Free Standing/Floor Attached
 363 seats (EM10)
 5'-8 1/2" Court To Step Dimension
 6'-4 15/16" Court To First Row Dimension

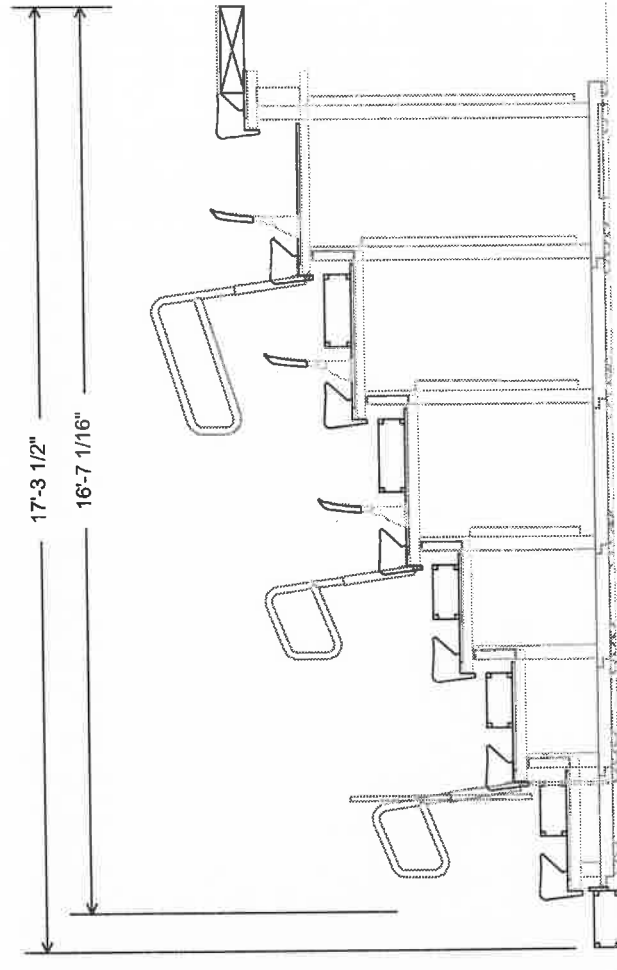
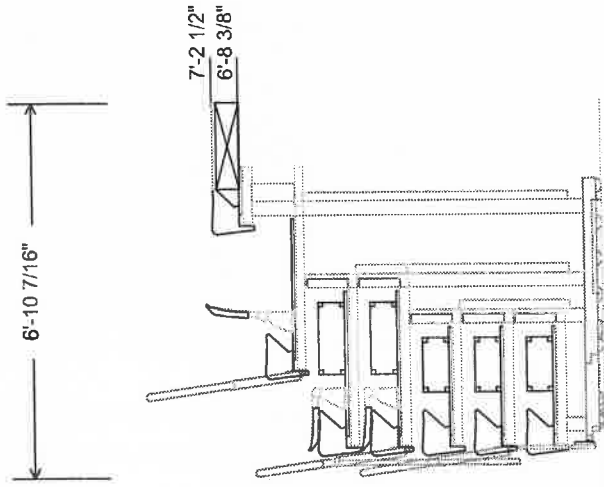

FLOOR IS CONCRETE

EXHIBIT 2

Side Elevation View A1



5981 East Cork Street, PO Box 2107, Kalamazoo, MI 49003-2107
 telephone (269) 349-1521 fax (269) 349-6530

Drawings produced by this program are only as good as the information provided. These drawings are PRELIMINARY only.
 All drawings created are subject to Interkal approval for design and construction capability.
 Printed: March 6, 2021 v2.7.5

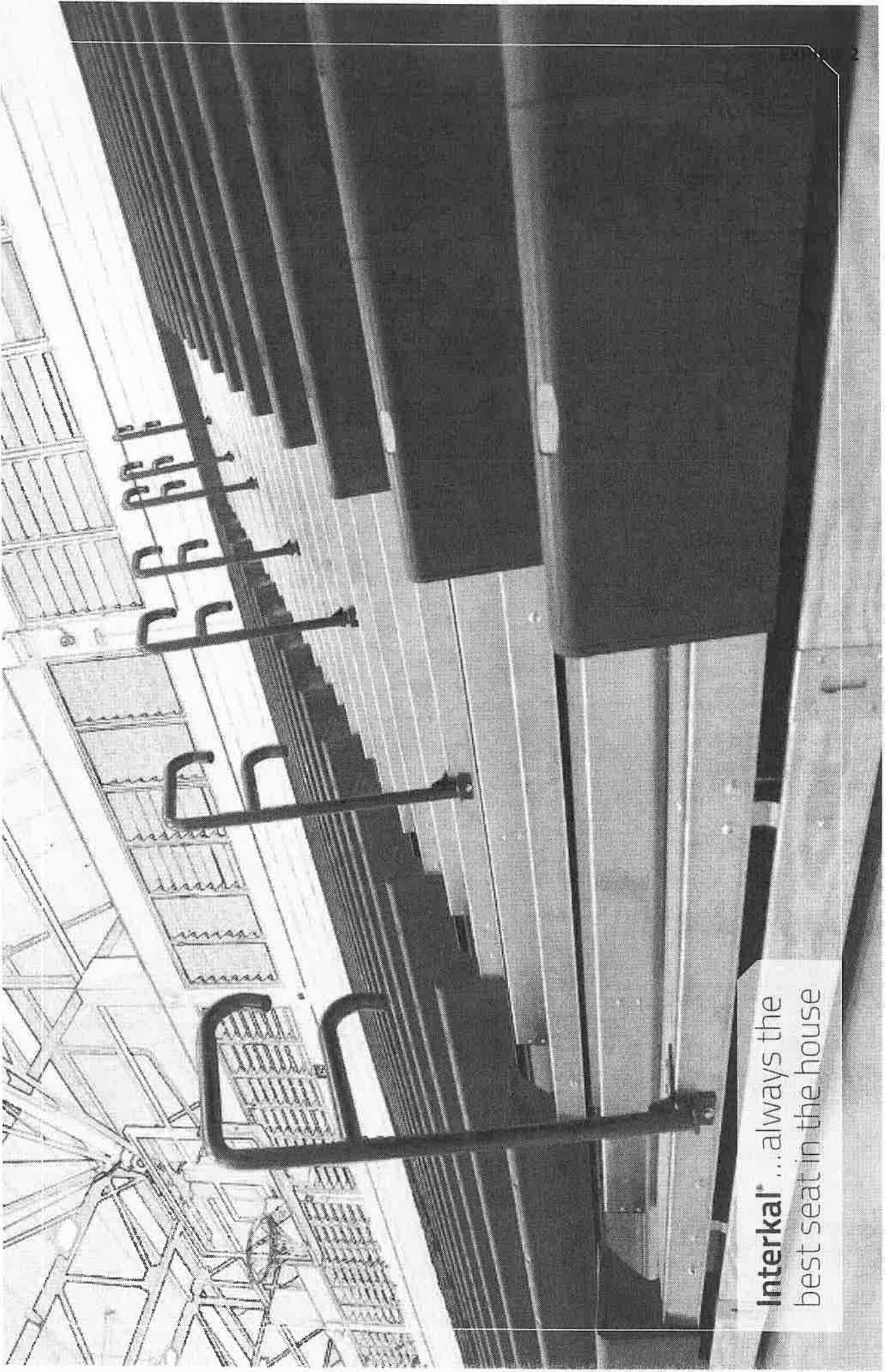

Interkal® ...always the best seat in the house

ESM™ Excel Seat Module

- 10" seat depth
- 18" seat width
- Seat numbers, row letters, and personal logos

PAGE 4



VISION™ Platform Chair

- Armrest cup holders (20" minimum seat width)
- Upholstered seat and back onsets
- Tablet arms

PAGE 14

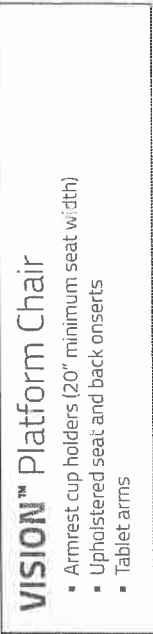

SSM™ Sculpture Seat Module

- 12" seat depth
- 18" seat width
- Seat numbers and row letters

PAGE 6



AURA™ Solid Stadium Chair

- Rear and armrest mounted cup holders
- Upholstered seat and back onsets
- End stanchion logos

PAGE 16



CSM™ Contour Seat Module

- 10" or 12" seat depth
- 18" seat width
- Seat numbers and row letters

PAGE 8



AURA™ Slat Stadium Chair

- Rear and armrest mounted cup holders
- Upholstered seat onsets
- End stanchion logos

PAGE 18



ComfoBack® Automatic Contoured Backrest System

- Available in 30", 32" or 33" spacing
- Fully-automatic or manual folding operation
- Powder-coated cast aluminum uprights

PAGE 10



UNITED™ Platform Chair

- Plastic or timber armrests
- Back panel in plastic or timber
- Seat numbers and row letters

PAGE 20

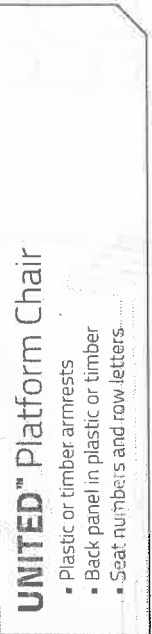

Classic Wood Bench Seating

- Dense southern yellow pine
- Grade BB or better
- Edge-glued and finger-jointed for strength and durability

PAGE 12



15 Standard Plastic Colors!

Choose from our wide range of standard colors for all Interkal seating types. All seating color options are complemented by light grey or black polydeck. Color depictions will vary slightly from actual color. Please contact your local Interkal representative to verify your color selection.

Custom colors are available upon request.

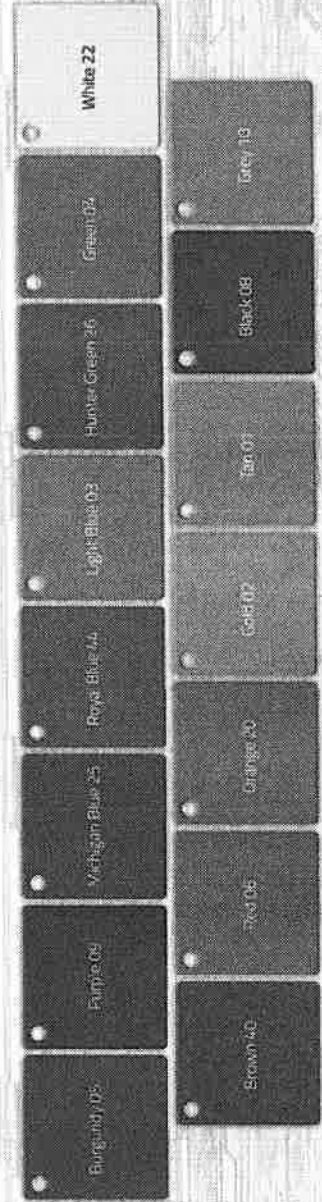

Solid Injection Molding

Recessed seat numbers, row letters, and personal logos

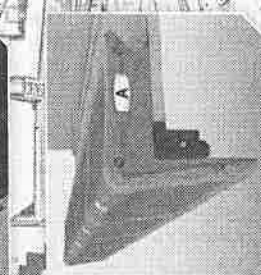
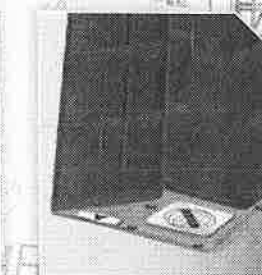
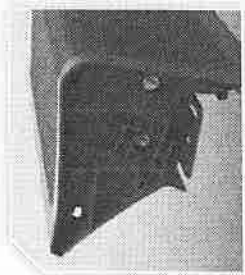

ESM 10" Excel Seat Module

Features

- Heavy steel bracket provides steel-to-steel through bolting at every 18" increment
- Structural ribs: Five vertical & three lateral
- Honeycomb design for unmatched vertical support
- Vandal-proof snap-lock feature with end caps

Durability

- Modules are constructed of one-piece injection molded high strength polyethylene which resists stains and will not splinter or warp. The molded-in solid color will not fade or wear out.
- For maximum rigidity, the specially designed attaching clamp provides a steel-to-steel connection of the module to the 14-gauge galvanized steel nosebeam.
- Each module incorporates a full perimeter interlock to secure one module to the next for increased strength.
- Five vertical and three lateral ribs inside each module provide superior support and are positioned for easy cleaning.

Easy Maintenance

- Easy to clean, easy to sweep—no obstructions at deck level
- No caddy traps or exposed hardware

Comfort

- Plastic seat modules are anatomically contoured to achieve greater spectator comfort.
- Each 10"-wide interlocking module provides a minimum adult seat height of 16".
- Low profile ESM for high rise applications (shown bottom left)

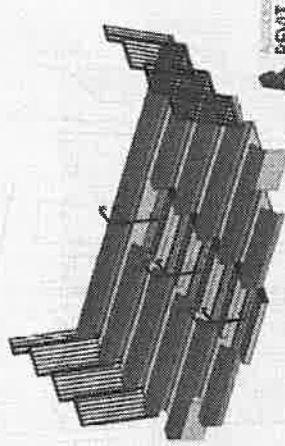
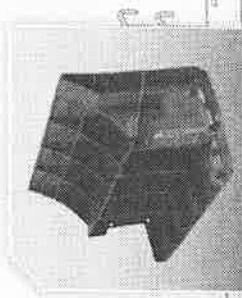

EXHIBIT 2

12" Deep Seats

Consistent full-depth seat for increased patron comfort



SSM™ 12" Sculpture Seat Module

Features

- Heavy steel bracket provides steel-to-steel through bolting at every 12" increment
- Structural ribs: Five vertical & two lateral
- End caps

Solid Color Seat Modules

- These modules feature redesigned end caps and a full 360-degree interior connection.
- Our wide range of 15 standard colors will complement any decor.
- Custom module colors, other than those shown, as well as contrasting end caps are available upon request. Color depictions will vary slightly from actual color. Please contact your local internal representative to verify your color selection.

Easy Maintenance

- Easy to clean, easy to sweep—no obstructions
- No debris traps or exposed hardware

Appearance

- A wide range of available colors dramatically increases aesthetic appeal and provides for interior design or actual color options
- Modular design concept clearly delineates each seat space and allows for ease of replacement should it ever become necessary. A recess in the module allows for optional seat numbering.
- Modules are available in 12" depths. The 12" Sculpture Seat Module requires a minimum of 24" back-to-back row spacing.

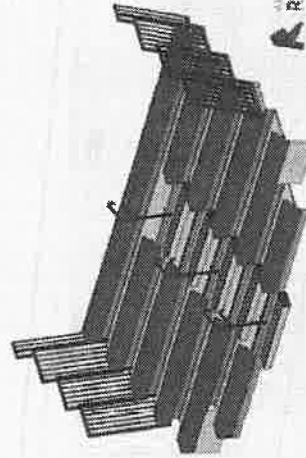
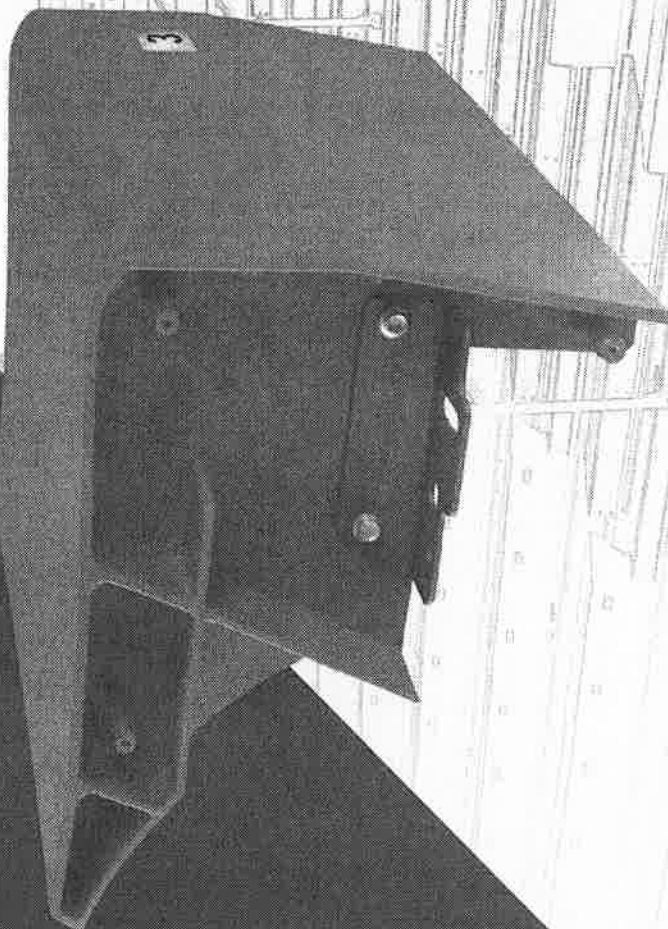

The Waterfall Face with a minimum 17" seat height offers unparalleled comfort

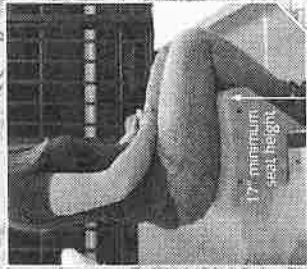
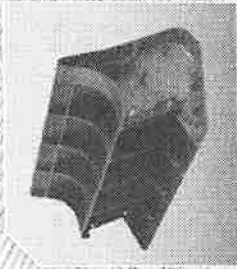

CSM™ Contour Seat Module

Features on the CSM™ include

- Heavy steel bracket provides steel-to-steel through bolting at every 18" increment
- Structural ribs: Five vertical & two lateral
- End caps
- Seat height—full 17" minimum
- Waterfall front allows for unparalleled comfort

Durability

- Modules are constructed of one-piece injection molded high strength polyethylene, which resists stains and will not splinter or warp. The molded-in solid color will not fade or wear out.
- For maximum rigidity, the specially designed attaching clamp provides a steel-to-steel connection of the module to the 14-gauge galvanized steel trussbeam.
- Each module incorporates a full 1/2" perimeter interlock to secure one module to the next for increased strength.
- Five vertical and two lateral ribs inside each module provide superior strength and are positioned for easy cleaning.

Comfort

- The "waterfall" front is highly functional as well as aesthetically pleasing. The additional seat height and angled face of the CSM allow patrons to pull their feet back underneath them, creating a smaller vertical envelope. This unique feature allows for the most comfortable experience, even in the tightest of quarters.
- Each 18"-wide interlocking module provides a minimum adult seat height of 17" for greater comfort, even over extended periods.

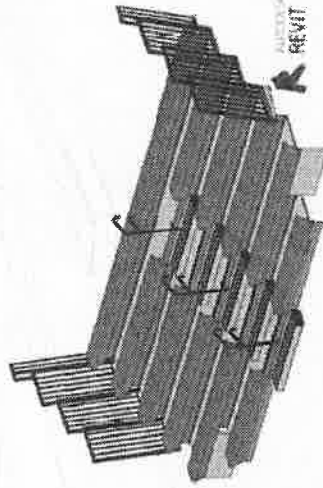

VIP Upgrade

Ergonomically designed backrests for maximum comfort at an affordable price

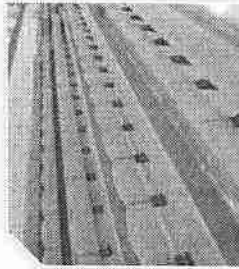
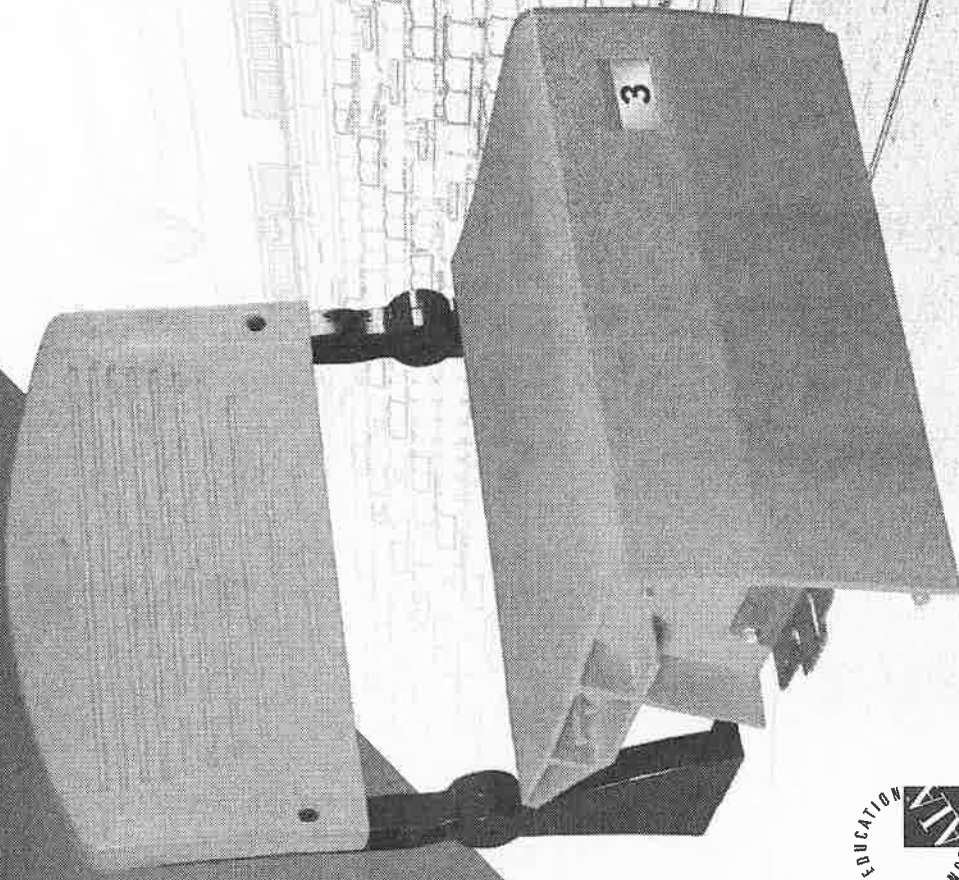

ComfoBack® Automatic Contoured Backrest System

Features & optional accessories

- Fully-automatic or manual operation
- 18" wide—Available with 30", 32", and 33" spans
- Available with 12" deep Sculpture Seat Modules
- A wide range of 15 standard colors
- A sleek appearance in the stacked position as well

1 Fully-Automatic Operation

Backrest raised and lowered with absolutely no labor required

2 Superior Comfort

Injection molded, ergonomically designed contoured back for superior comfort

3 Concealed Spring Mechanism

Concealed spring mechanism to eliminate pinching hazard

4 Black Powder-Coated

Cast aluminum uprights

5 Color Selection

Available in contrasting or matching module colors

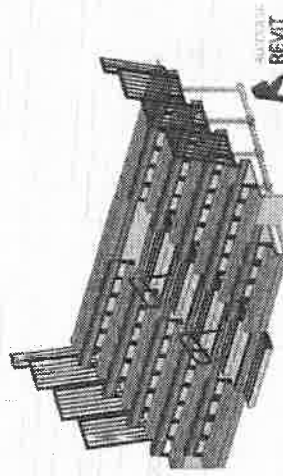
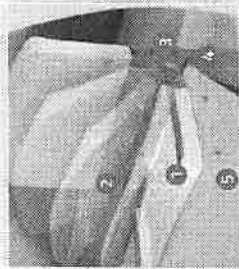

Southern Yellow Pine Lumber
 Seat and riser boards are richly finished in classic style to greatly enhance the appearance of any gymnasium or fieldhouse

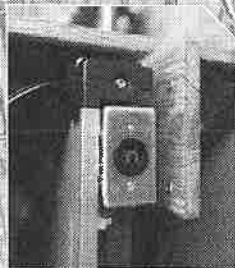
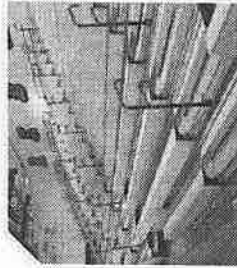
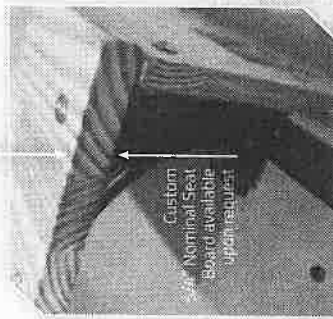

Classic Wood Bench Seating

Features

- Dense southern yellow pine, grade BB or better
- Laminated, edge-glued, and finger-jointed construction of wood boards for greater strength and durability
- Standard wood thickness: 1" nominal (¾" actual)
- All boards finished on both sides and all edges
- Seats and front risers firmly secured every 36" to welded steel seat supports which attach to the continuous nosebeam for excellent stability
- Triple-sanded and sealed with moisture-resistant urethane
- A high-gloss urethane applied for added protection and to accentuate the richness and beauty of the wood
- Standard seat board depth 8 ½" with 10" deep wood seat boards available upon request

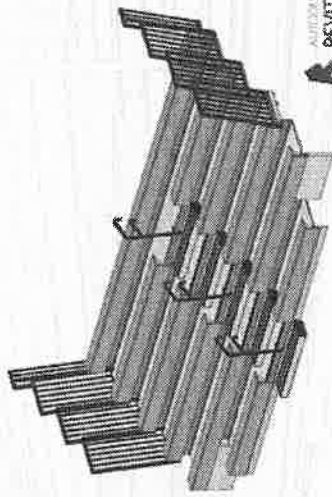

EXHIBIT 2

INTERNAL SEATING WORLDWIDE



VISION™ Platform Chair

With its blow-molded plastic components and cast aluminum brackets, the VISION offers a unique combination of comfort and structural integrity.

Features & optional accessories

- Cup holders (20" minimum seat width)
- Upholstered seat and back inserts
- Tablet arms
- Seat numbers and row letters
- Available in 15 standard colors

The VISION maintains its seat pan width from front to back to make for a comfortable experience for patrons of all shapes and sizes.

Three types of fold-down operation to accommodate your individual needs

- Manual
- Semi-manual with assisted release
- Semi-automatic

Dimensions

- Available in 19.0" to 24.0" (483mm - 610mm) seat widths
- Minimum 10 1/2" (266.35mm) rise per row
- 18" (457mm) wide seats available in an armless option
- Available in 30", 32", and 33" (762mm, 813mm, and 838mm) row spacing

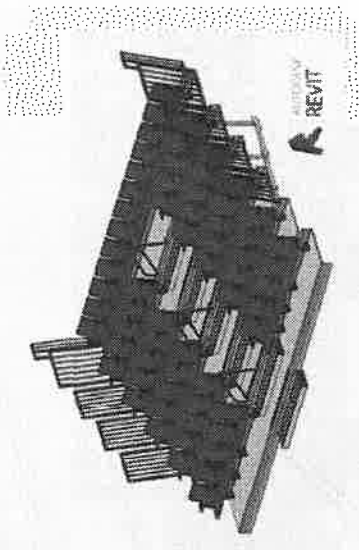
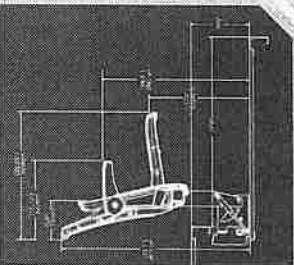
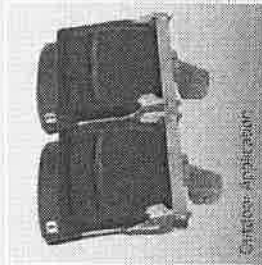

AURA™ Solid Stadium Chair

Unmatched comfort, style, and durability

Powder-coated cast aluminum stanchions will not rust, ensuring that your AURA stadium chairs will maintain their new look for many years to come.

Features & optional accessories

- Floor or riser mounted stanchions
- Cup holders
- Upholstered inserts
- ADA easy access stanchions
- Seat numbers and row letters
- 15 standard colors
- End-stanchion logos

ADA easy access stanchions

Utilizing the proven design of a stanchion-to-stanchion cross shaft, through the seat pan, the AURA provides strength and durability that can be counted on over time.

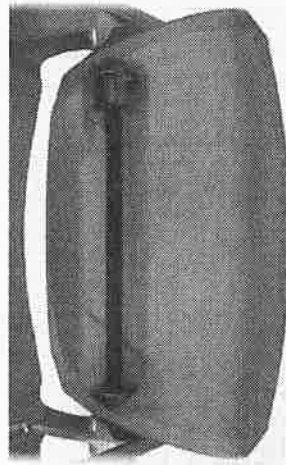
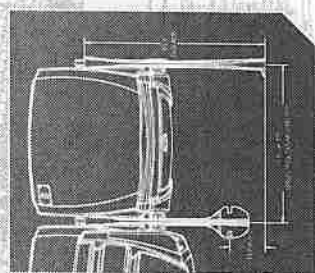
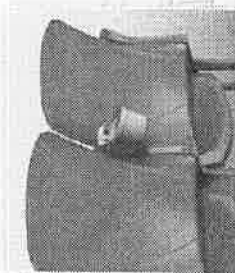
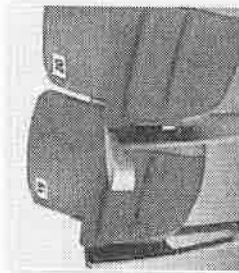
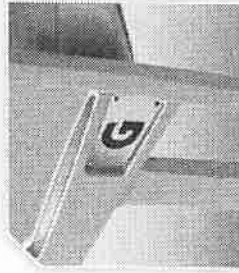

EXHIBIT

MASTER CATALOG



INTERNAL SPECIATOR SEATING WORLD WIDE

15

AURA™ Slat Stadium Chair

Unmatched comfort, style, and durability

Powder-coated cast aluminum stanchions will not rust, ensuring that your AURA stadium chairs will maintain their new look for many years to come.

Features & optional accessories

- Floor or riser mounted stanchions
- Cup holders
- Upholstered seat inserts
- ADA easy access stanchions
- Seat numbers and row letters
- 15 standard colors
- End stanchion legs

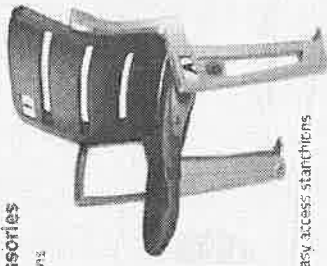

ADA easy access stanchions

Utilizing the proven design of a stanchion-to-stanchion cross shaft through the seat bar, the AURA provides strength and durability that can be counted on over time.

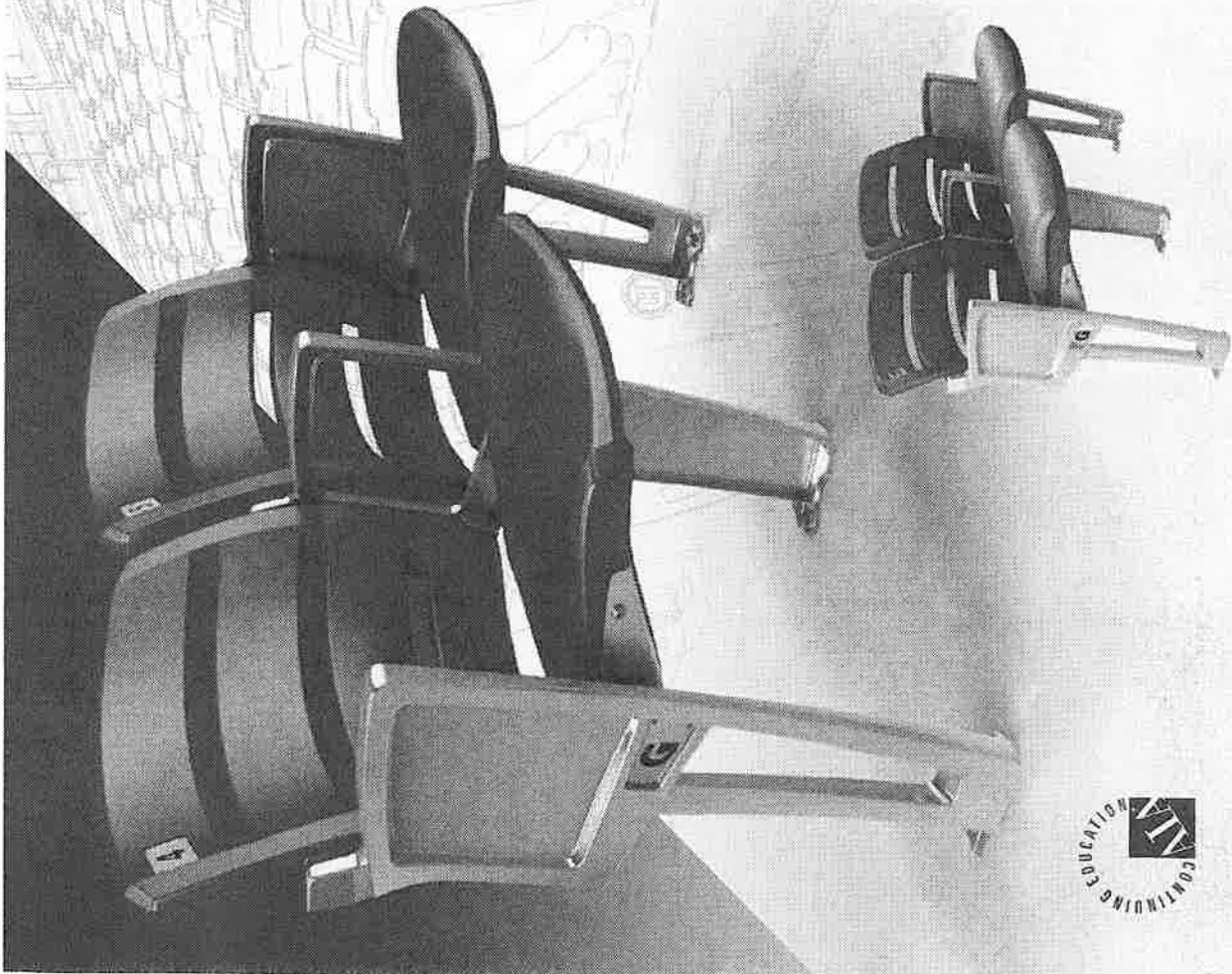
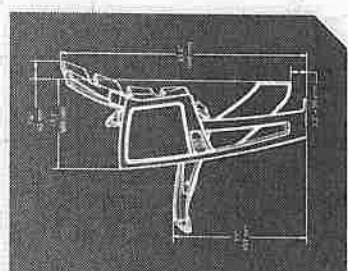
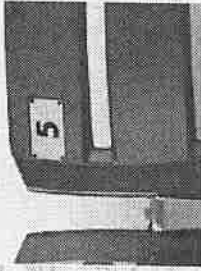
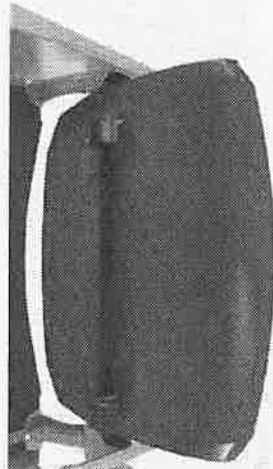

The United Chairs' unique flexibility allows for endless options in both fixed and telescopic applications

UNITED™ Platform Chair

Offering all the styling and comfort of an auditorium chair combined with complete flexibility, the United is suitable for both fixed seating and telescopic installations. The optional pocket spring seat pan provides a luxurious feel to the chair and its unique rising action creates wide, safe walkways.

Features

- Self-rising design, with auto-rise armrest and the backrest acting as a counterweight
- Compact dimensions when closed
- High backrest for concert-level comfort
- Optional protective plastic panel to the back
- Pocket sprung seat core for outstanding support
- Elegant curved timber armrests

Accessories

- Trolley outer back
- Protective plastic outer back
- Seat numbers
- Row letters
- Cup holder

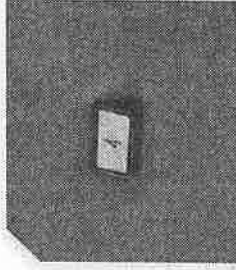

The strongest understructure in the industry!

The Interkal understructure is designed for maximum load-bearing capacity and eliminates deflection. It is constructed from the strongest and most durable materials in the industry for dependable performance you can count on for years to come. Because this understructure has few moving parts, trouble-free operation is assured with routine maintenance.

Sway Braces: All Interkal seating systems are stabilized by sway braces attached to the vertical columns and steel risers for maximum strength and resistance to movement. Sway braces not required on rows 1 and 2. Sway braces fabricated from steel are essential for vertical post bleachers to resist the compression and tension forces created when the bleachers are loaded.

Vertical Posts: Electric-welded continuous 2" x 3" closed seam, rectangular structural steel tubing produces the strongest and safest vertical columns. Post size increases depending on row height and load-bearing requirements.

Deck Supports: Deck support brackets are more rigid than competitive designs to help prevent sagging and potential binding during operation. All deck supports incorporate rollers for efficient operation and deck stability.

Rise Beams: All Interkal seating options incorporate a structural continuous galvanized nose beam, resulting in a uniform understructure. This component provides superior strength, continuous support for the plywood deck, and the flexibility to achieve any aisle location configuration.

Superslide System: The low-friction flexible rod system guarantees positive engagement of vertical supports without binding, ensuring smooth operation over uneven floor conditions. The superslide system maintains proper vertical column spacing, reduces wear, and helps eliminate racking damage.

Row Locks:

- Stabilize the bleacher under load in the extended position by securely locking each support post to an adjacent post.
- Automatically engage and release for opening and closing operation.
- Individual row locks make it possible to open any number of rows without opening the entire bank of bleachers.

H Beams: The aluminum "H" Beams located at every plywood joint provide continuous support from rear riser to nosebeam. It also facilitates ease of cleaning by eliminating unsightly gaps.

Wheel Channels:

- Wheel channels accommodate 8 to 12 wheels per channel for maximum weight distribution and operating ease.
- Wheel channels are precision formed from a single piece of steel coil for maximum rigidity.

Heavy-duty composition rubber wheels are provided in a 3 1/2" diameter by 1 1/2" tread width.

All wheels are provided with a 1/2" diameter steel axle secured with tamper-proof retaining rings.

Wheels are equipped with oil-impregnated sintered metal bearings to assure smooth operation.

Deck Support Rollers: Nylon rollers at the top of every deck support minimize friction for smoother, quieter operation and enhanced deck stability. Our rollers eliminate steel-to-steel contact which would hinder the operation of the bleacher.

Riser Beam:

Multi-bend component provides superior structural integrity.

Section Joint:

18" steel plates at every nose and riser to ensure the most rigid section joint available.

Safety Features

Safety is the first and foremost concern in each and every Interkal design. The following key safety features are available:

- Limit switches on non-friction automatic power systems
- Plastic covers at every nosebeam exposed end and/or handicap location
- Removable pendant control attaches to the front of the seating system for added visual safety during operation of all automatic power systems
- Superslide System to insure positive engagement of all vertical posts
- Rear closure panels to prevent debris from collecting under units
- Aisles and rails in compliance with applicable code requirements

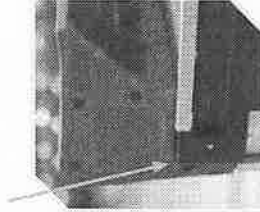

Riser Splice B-bolt pattern

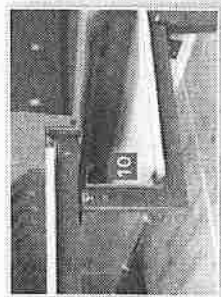

Nosebeam Splice web-bolt pattern

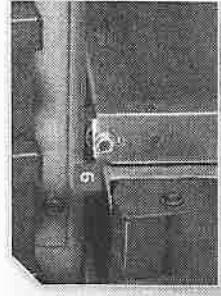

Row Lock

7

2

3

10

4

6

8

Interkal supports the NFPA-102 mandate for annual bleacher inspection and maintenance. We strongly recommend a routine maintenance program.

22 INTERNAL SEATING SYSTEMS

Applications: Telescopic Systems to fit a variety of facility configurations

Reverse-Fold Systems

(shown upper level, below) are designed for applications where space behind the bleacher stack is desired for other activities when the bleacher is not in use. This is common in areas such as mezzanines or balconies. Up to 18 rows can be specified with this system (over 18 rows, consult factory).

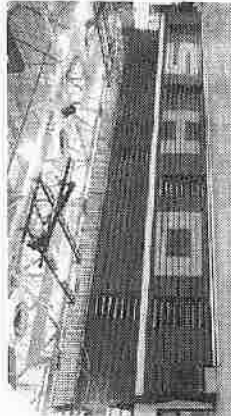

Forward-Fold Systems

(shown lower level, below) are the most typical application of telescopic seating in which the bleachers open in the forward direction. They are available up to 24 rows (over 24 rows, consult factory) and utilize either wall attachment or free-standing floor attachment.

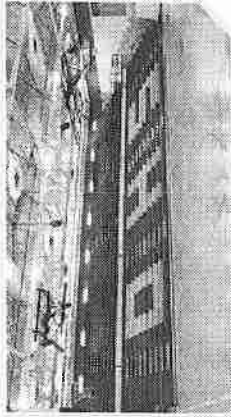

Recessed Systems (below)

require minimal clearance to fit conveniently under a balcony overhang and maximize usable floor space when the bleachers are stacked. Available with any of the internal seating options up to 24 rows (over 24 rows, consult factory). Add one of our automatic power options for easy operation.



Mobile Systems (shown below left)

consisting of single sections of bleachers can be used in one part of a building and stored in another. They offer increased flexibility and are available with any seating option up to 14 rows at 10", rise and 12 rows at 1 1/2" rise (over 14 rows, consult factory). Portable hydraulic dollies are provided for transport to various spectator or storage areas.

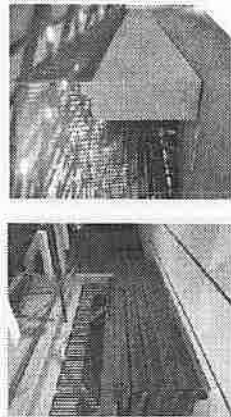

Custom Seating Arrangements Available:

- Pie-shaped sections for radius configurations (shown far right)
- Truncated sections / notchouts to comply with the Americans with Disabilities Act (ADA) requirement for wheelchair seating
- Elevated front and rear walkways and cross aisles as required for code compliance, as well as improved sight lines
- Cut-outs for columns that extend out from rear wall

Please consult factory on these and other custom seating arrangements.

Self-Storing Aisle Rails

The Perfect Solution For Saving Set-Up Labor

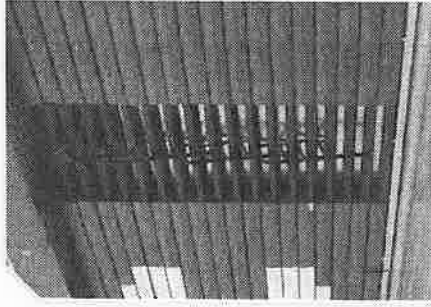

- Aisle Rails are permanently bolted in position and automatically store in the deck, ensuring that the rails are in place at all times for spectator safety.
- This innovative design eliminates the need to individually set up each rail, maximizing labor savings.
- Revolutionary Patented Self-Storing Aisle Rails (SSAR) are exclusively from the leader in telescopic seating—Interkal!

Provisions to Comply with ADA

We Engineer Flexibility Into Your ADA Compliance

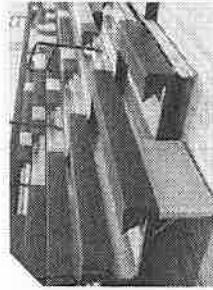

36" wide, 1-row deep single notchout



Double 1-row deep recoverable notchout shown in ADA mode

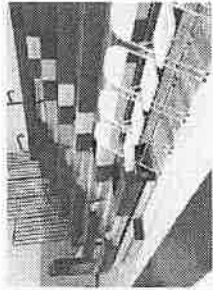

Recovered 1-row deep truncations

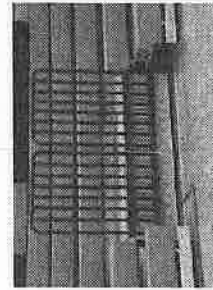

1-row deep double notchout with optional front rail

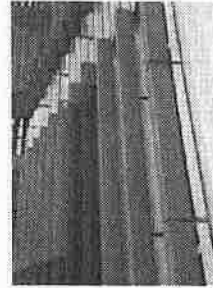

Double 1-row deep recoverable notchout shown in recovered mode

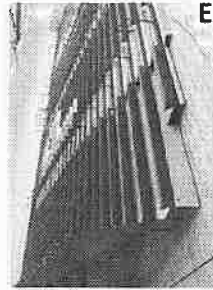

Double 1-row deep permanent notchout

EXHIBIT

MASTER CATALOG

Power Options

Nonfriction Power System (Right)

This is a fully-automatic power system designed to open and close wall-attached, recessed or reverse-fold telescopic bleachers at the touch of a button—without the need for traction force on the floor. Typically used for higher-row applications, it has the capacity to move more rows of bleachers than any other mechanical power system developed for the telescopic seating market. Limit switches are used to stop the 2-HP, 208-230VAC, 3-phase motor in the fully open or closed positions. The chain drive pusher links assure years of dependable performance as well as nonslip, straight-line operation.

Wide Track Power System (Below)

Our Wide Track Power System is U.L. listed and incorporates friction drive rollers as an integral part of the first row horse assembly. The two friction roller assemblies are linked by a continuous drive shaft driven by a ½ H.P., 208V, 3-phase motor. This continuous drive shaft controls drive roller operation in a straight, efficient manner—especially important on bleacher banks which include numerous notchtubs or truncations.

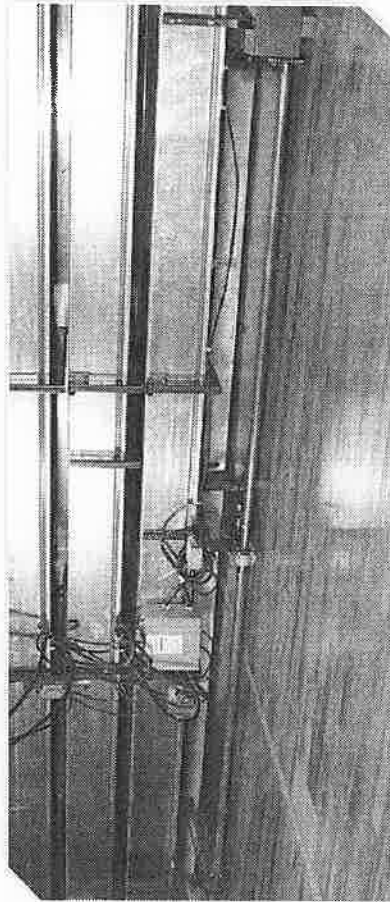
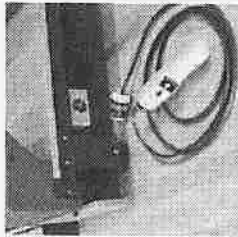
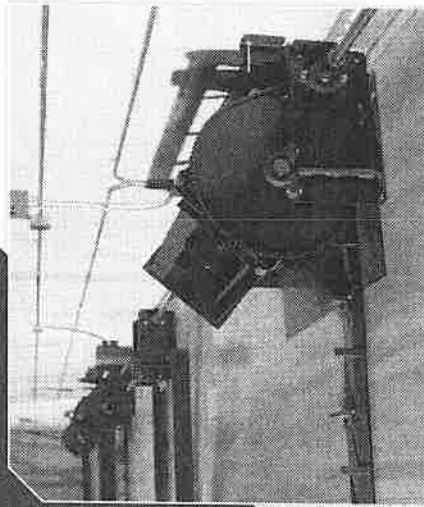

Options & Accessories

1 Safety End Rails

are required on open ends of telescopic seating systems. Our self-storing end rails offer great convenience. These are designed and tested to meet all current building code requirements. Removable end rails are also available when required.

2 Vinyl Side Curtains

close off the ends of the bleacher with a heavy-duty laminated vinyl. Grommets at every hanger location, chainweight bottom hem. Available in 13 colors.

3 Aisle Center Rails

are installed on alternating rows and are available in both self-storing or quarter-turn types. Removable aisle rails are available when required.

4 Intermediate Steps

are designed to comply with applicable code requirements by providing an equal depth and height foot surface between rows. Safety abrasive tread is provided on all steps.

5 Video Platforms

are engineered to provide a stable platform for filming sporting events safely-integrated right into the seating system.

6 Removable Tinner's Table

is an 18" by 96", high-pressure laminated work surface with removable legs which can be utilized at any location. The table leg assembly is constructed of tubular steel and the legs are easily removed for storage within the seating system.

7 End Panels

are designed to deter access behind units in the stored position.

8 Back Rails & Panels

are used on mobile, free-standing and reverse-fold units to provide added safety and close off access to the understructure.

9 Black Polydeck

offers a unique, sharp upgrade to our standard grey polydeck.

Additional Accessories

- Forward travel (aisle recovery for reverse fold units)
- Seat numbering on seat modules
- Vinyl ball-doll actors
- Front rails
- Extended back panels
- Column cut-outs
- Balcony access steps

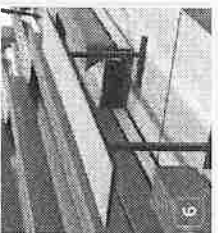
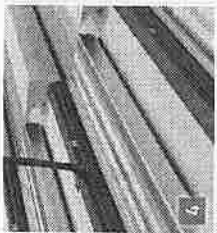
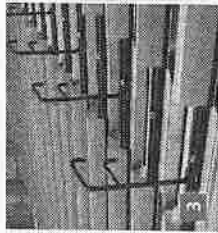
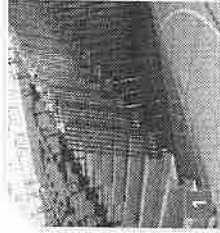
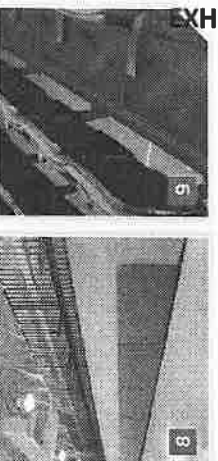
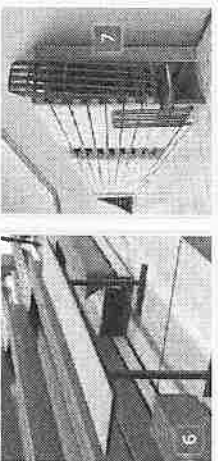
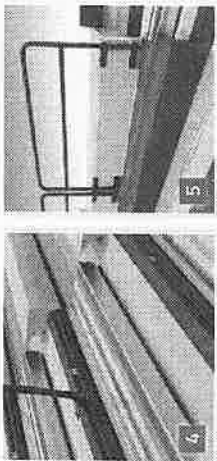
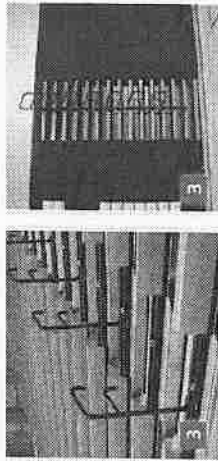
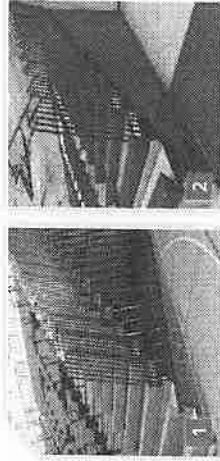



Interkal® ...your solution
for spectator seating